

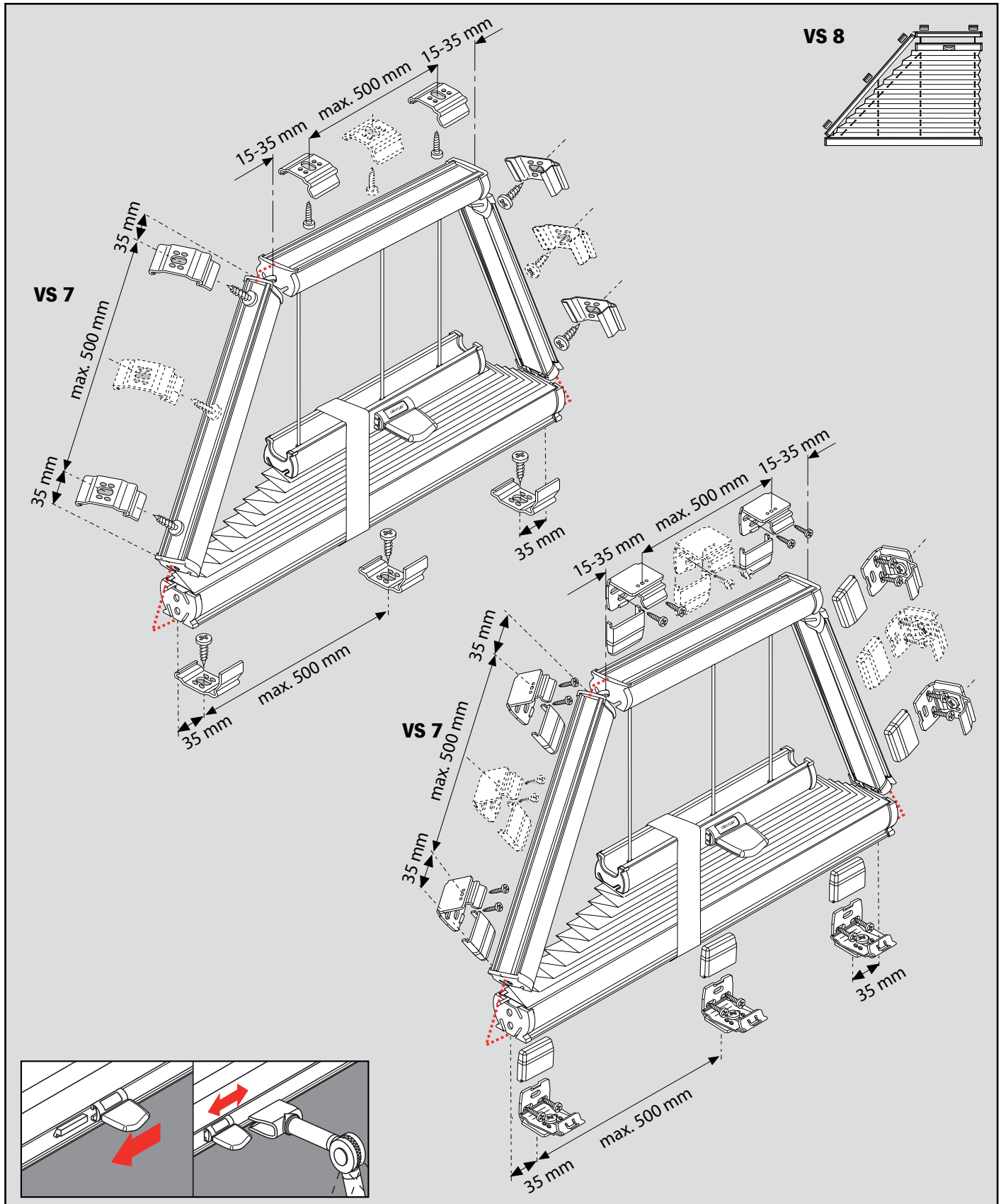

# Plisse „VS 7, VS 8“

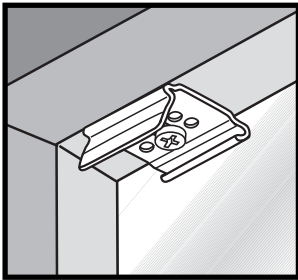



**Montáž mezi zasklivačí lišty (uchycení CA)**  
**Falzmontage (CA Befestigung)**  
**Top fixing (CA fixation)**  
**Bevestiging in de sponning**  
**Dans la feuillure**  
**Montaggio nella piegatura**  
**Montaż w świetle szyby**  
**Монтаж в проем**

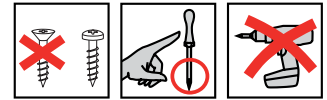

**Montáž • Montage**  
**Fitting • Montaggio**  
**Montaż • Монтаж**

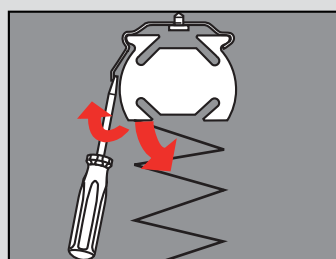
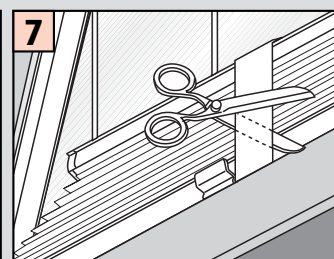
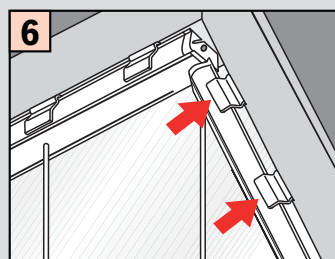
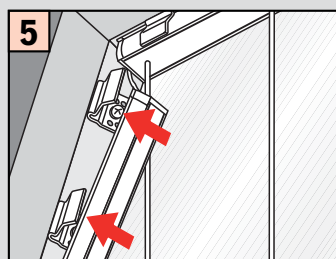
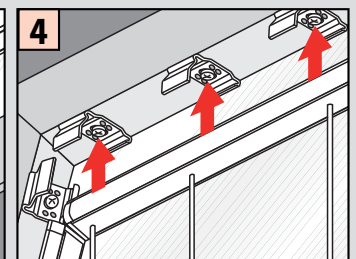
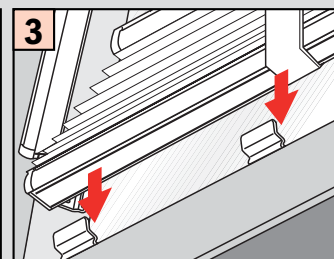
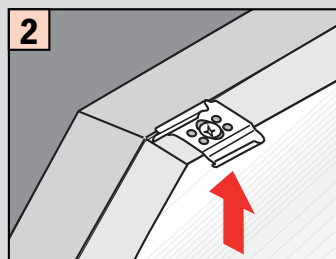
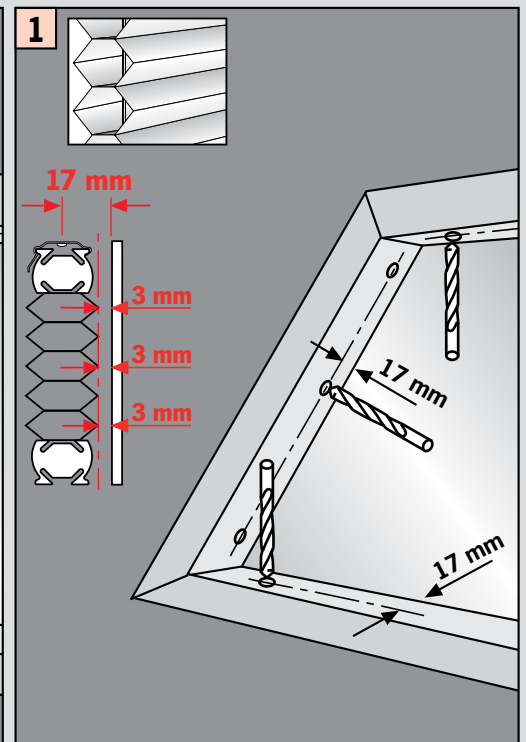
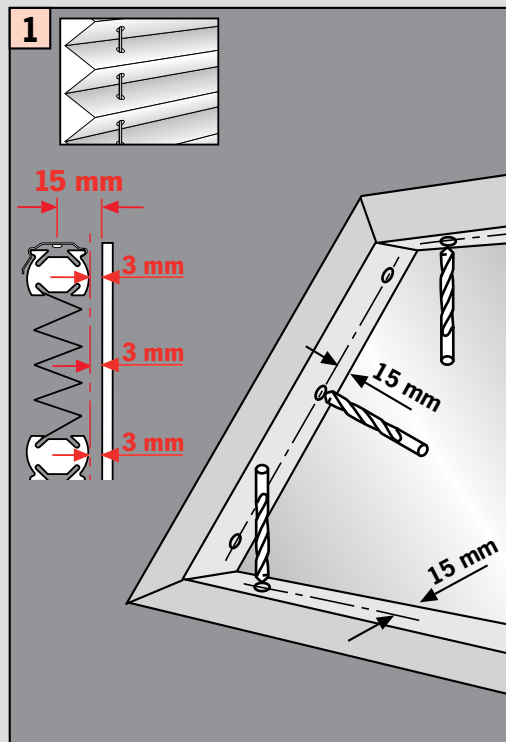

**Demontáž • Demontage • Disassembly • Démontage**  
**Smontaggio • Demontaż • Демонтаж**

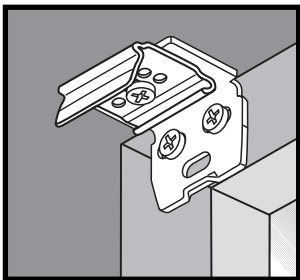

**Montáž na rám okna (uchycení CB pomocí stěnového úhelníku)**  
**Winkelmontage (CB Befestigung)**  
**Face fixing (CB fixation)**  
**Bevestiging met hoeksteun**  
**Avec equerre de fixation**  
**Montaggio mediante angolare**  
**Montaż frontalny (nawierzchniowy)**  
**Монтаж на проем**

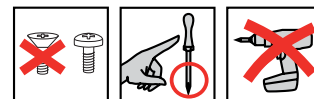

**Montáž • Montage**  
**Fitting • Montaggio**  
**Montaż • Монтаж**

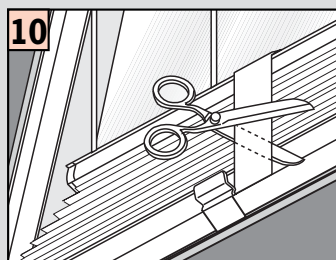
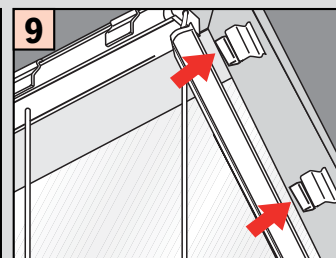
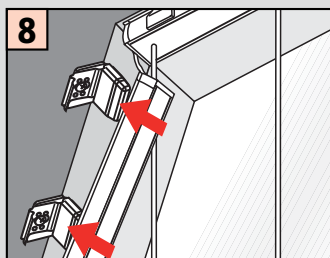
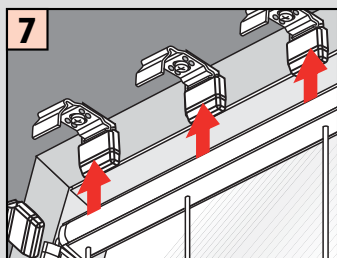
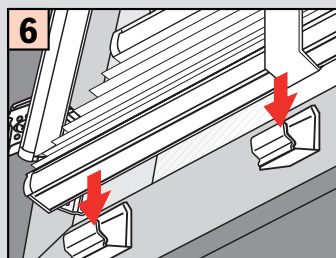
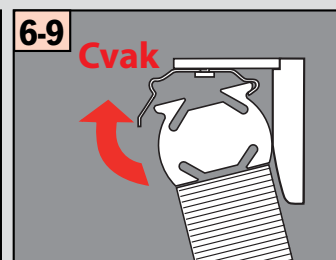
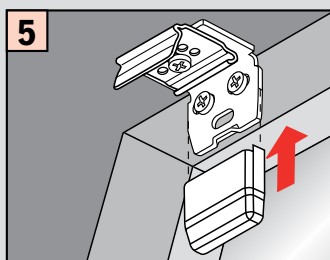
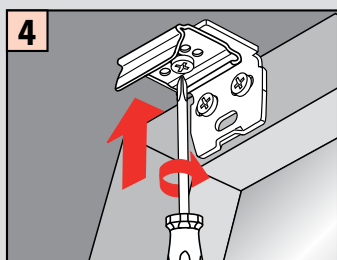
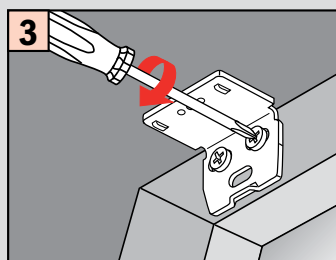
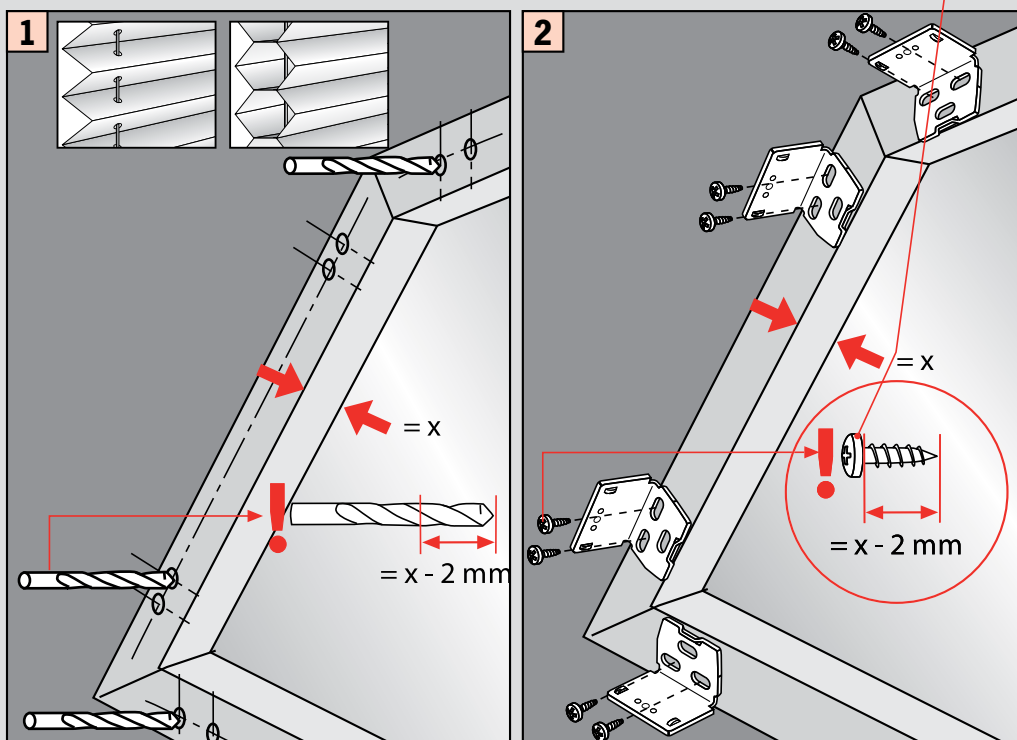

**Demontáž • Demontage • Disassembly • Démontage**  
**Smontaggio • Demontaż • Демонтаж**

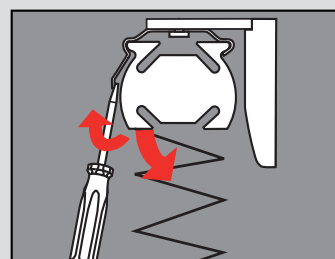

**Montáž klipu pomocí adaptéru**  
**Clip-Montage mit Ausgleichskeil**  
**Clipinstallation with adapter**  
**Clip met compensatiewig**  
**Clipmontage avec immobilisation**  
**Clip con staffa di compensazione**  
**Montaż z klinem poziomującym**  
**Монтаж с компенсирующим клином**

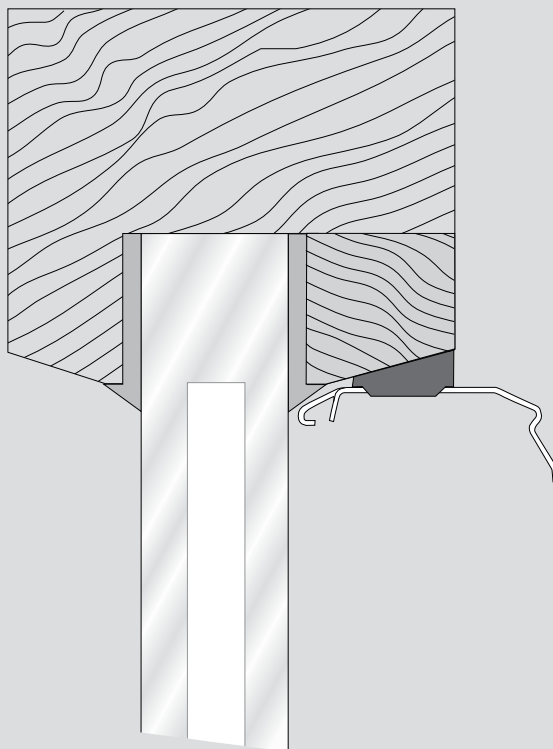

**A Standardní klip s adaptérem**  
**Clip Standard mit Ausgleichskeil**  
**Clip standard with adapter**  
**Standaardclip met compensatiewig**  
**Clip standard avec clavette de compensation**  
**Standard con staffa di compensazione**  
**Wieszak klip standard z adapterem**  
**Держатель клипса Standard с адаптером**

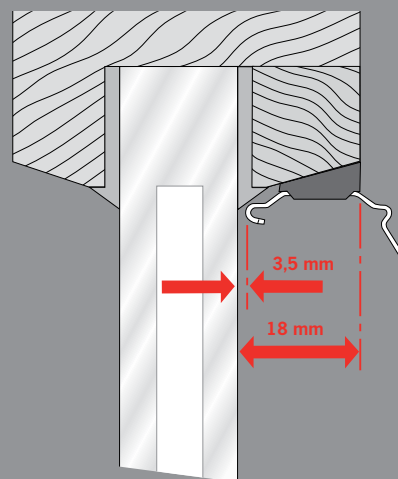
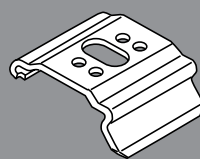

**Adaptér 11° - 44°**  
**Ausgleichskeil 11° - 44°**  
**Adapter 11° - 44°**  
**Compensatiewig 11° - 44°**  
**Immobilisation 11° - 44°**  
**Compensazione 11° - 44°**  
**Klin poziomujący 11° - 44°**  
**Компенсирующий клин 11° - 44°**

